

# INSTRUCCIONES DE ARMADO (SP210-1)

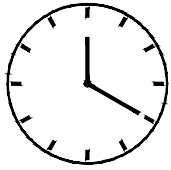

a=10

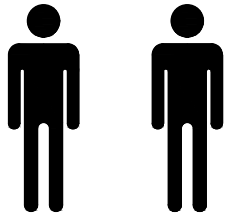

b=4



c=4



d=8



e=1

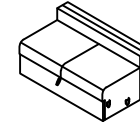
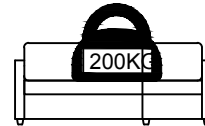
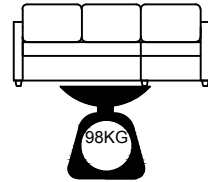
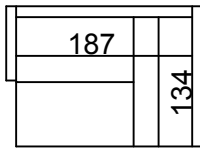
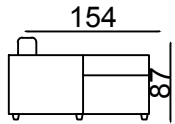
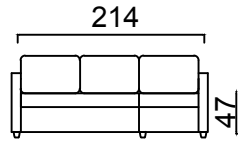

A=1

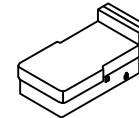

B=1

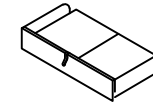

C=1

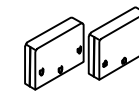

D=2

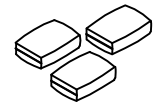

E=2

Step 1

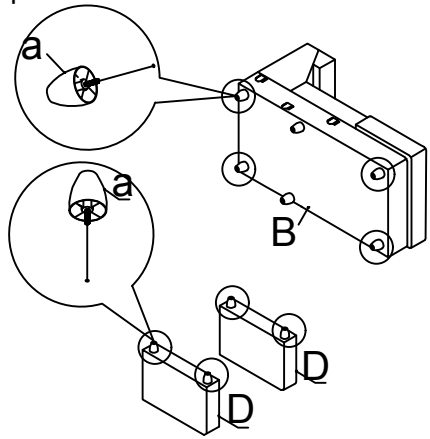

Step 2

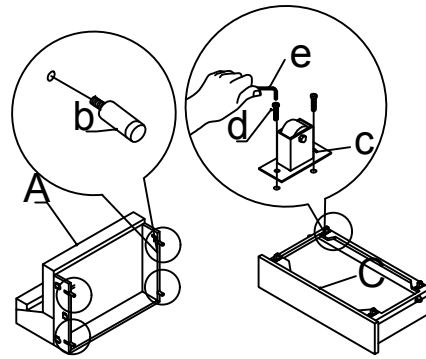

Step 3

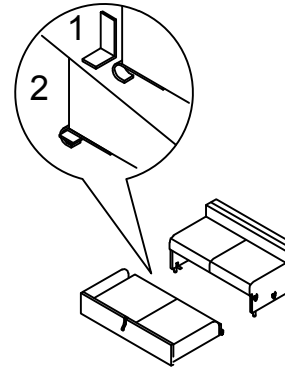

①



②

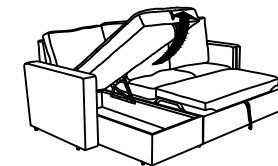

③

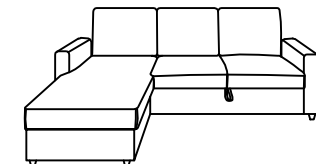

Step 4

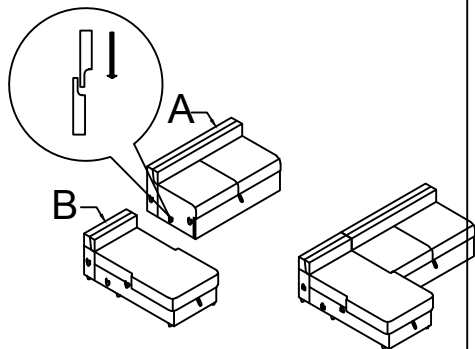

Step 5

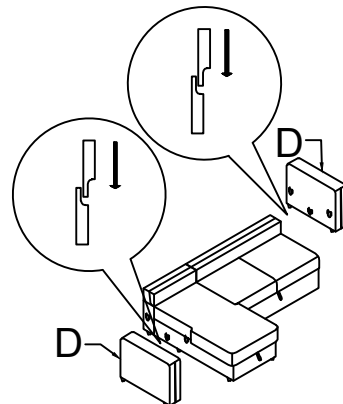

Step 6

