

# Cassini Bed Frame

Single

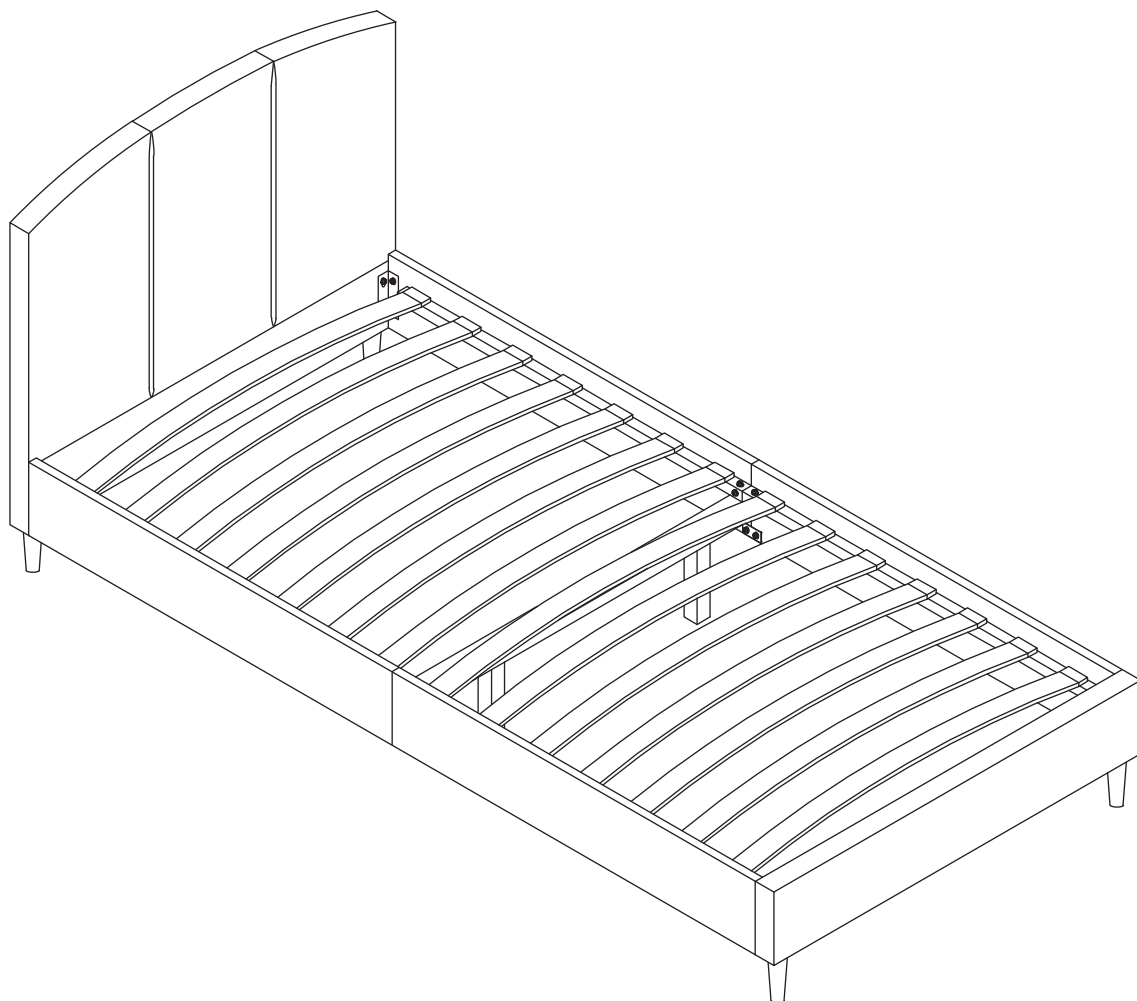

1 hour approx  
assembly time



Two person  
assembly

**Dreams**

# Thank You

Dear Customer, Thank you for choosing to purchase your bed from Dreams - we hope it brings you your best ever night's sleep. Before you begin building your bed, please take a moment to read through the instructions and make sure that you've got all the relevant parts listed on the following pages.



## Assembly tips

Before you begin, it's best to identify all parts and fittings to build your bed. We advise laying these out on the floor to check you have everything, and familiarising yourself before building.



## Top tip

We recommend that you build your new bed in the room you'd like it to be located - this will help prevent any risk of damage to your newly built bed whilst moving it.



## Safety and care

It's really important to ensure children and animals are kept away from the assembly area, as there are small components used in this bed which could present a choking hazard. All plastic and wrapping materials should also be kept away from children and animals to prevent any risk of suffocation. To keep your little ones busy, there is a colouring page inside the back cover.



## Help and support

At Dreams, it's our mission to give the whole nation a great night's sleep - this means that the quality of our products is of utmost importance to us. If there are any issues with your product or any missing parts, please contact our Help Centre on 0800 652 6750, where a member of our team will be happy to help. (For customers based in Northern Ireland, please call 028 9050 8300)



## Recycling

Please ensure that packaging is disposed of in a safe and environmentally friendly way, and recycle where possible. Our assembly instructions are printed on recycled paper. Please keep your assembly instructions safe to refer back to in the future.

# Parts

## Important information

The bed you have purchased comes complete with everything needed to build your bed in one box so please follow the instructions below in the current order. Before you begin assembling your bed, please take a moment to read through the instructions and make sure that you've got all the relevant parts listed on the following pages.

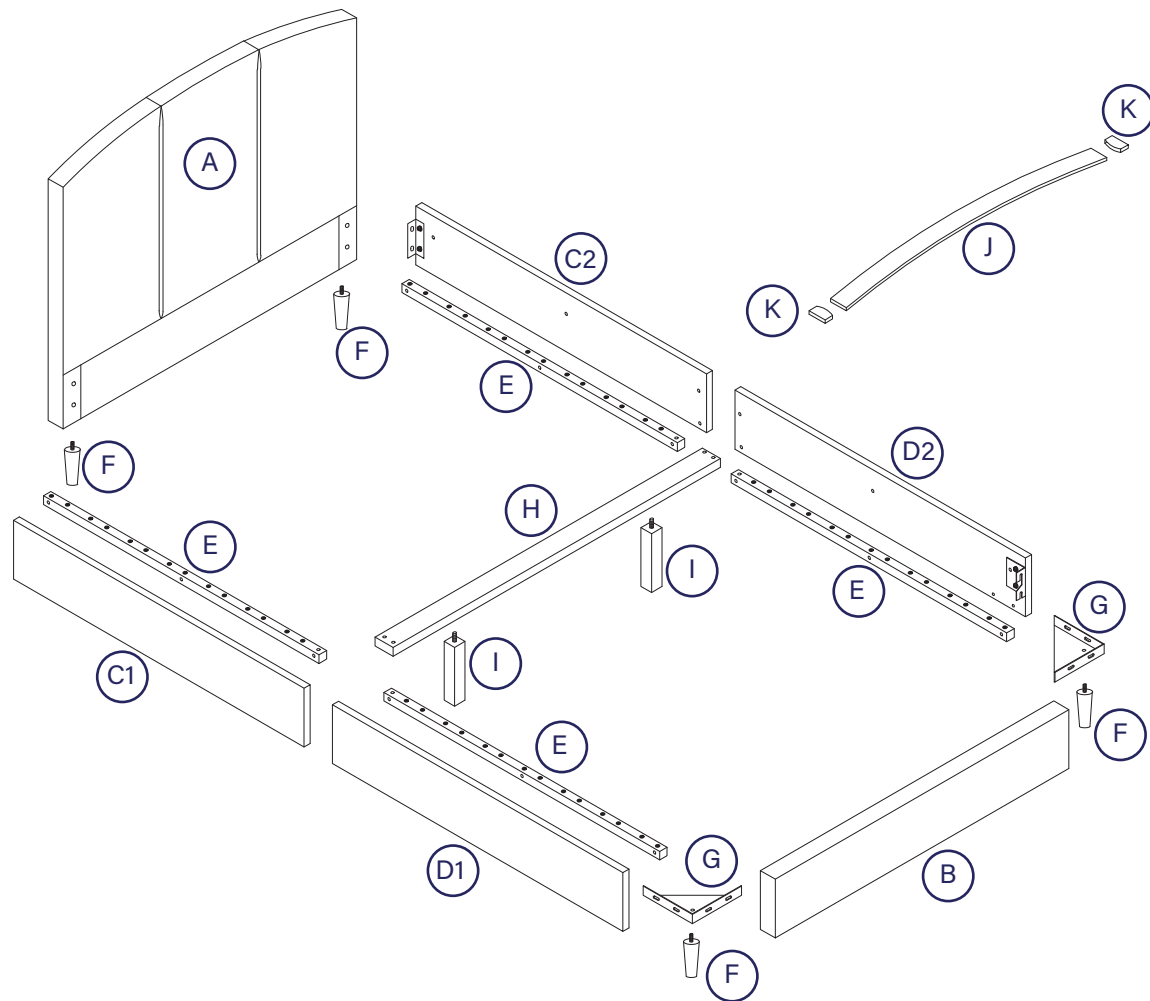









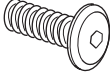
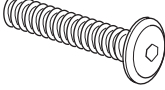

## Parts list

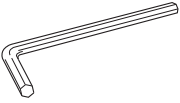
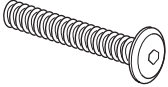
A.	Headboard	1	G.	Angle Brackets	2
B.	Footboard	1	H.	Cross Support Rail	1
C1&C2.	Side Rails - Headend Left & Right	1 Pr	I.	Cross Rail Support Legs	2
D1&D2.	Side Rails - Footend Left & Right	1 Pr	J.	Bentwood Slats	14
E.	Slat Support Rails	4	K.	Single Plastic Slat Caps	28
F.	Legs	4			

# Fittings

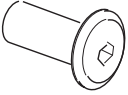
Please check you have all the parts listed below with your product:

## Hardware included for bed assembly

<b>a x16</b>  Bolts (M8x20mm)	<b>b x4</b>  Bolts (M8x25mm)	<b>c x12</b>  Bolts (M8x40mm)	<b>d x34</b>  Spring Washers for M8 bolt	<b>e x34</b>  Flat Washers for M8 bolt
<b>f x1</b>  Allen Key for M8 bolts	<b>g x4</b>  Bolts (M6x45mm)	<b>h x4</b>  Spring Washers for M6 bolts	<b>j x4</b>  Flat Washers for M6 bolts	<b>k x2</b>  Allen Key for M6 bolts
<b>l x4</b>  Sleeve Nuts for M6 bolts	<b>m x2</b>  Metal Connection Plates	<b>n x2</b>  Nuts for M8 bolts	<b>o x1</b>  Spanner for M8 nuts	

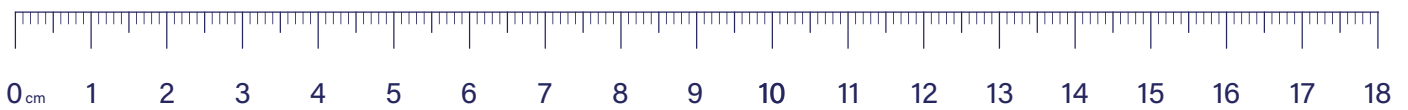

# Tools required



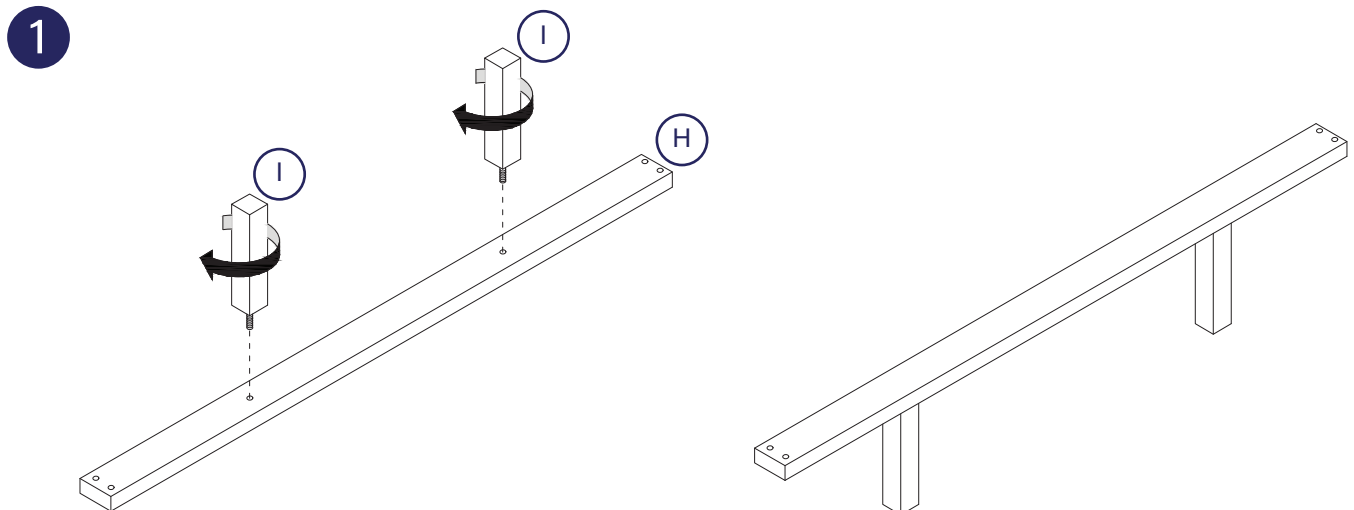

No more tools needed.

# Bed assembly





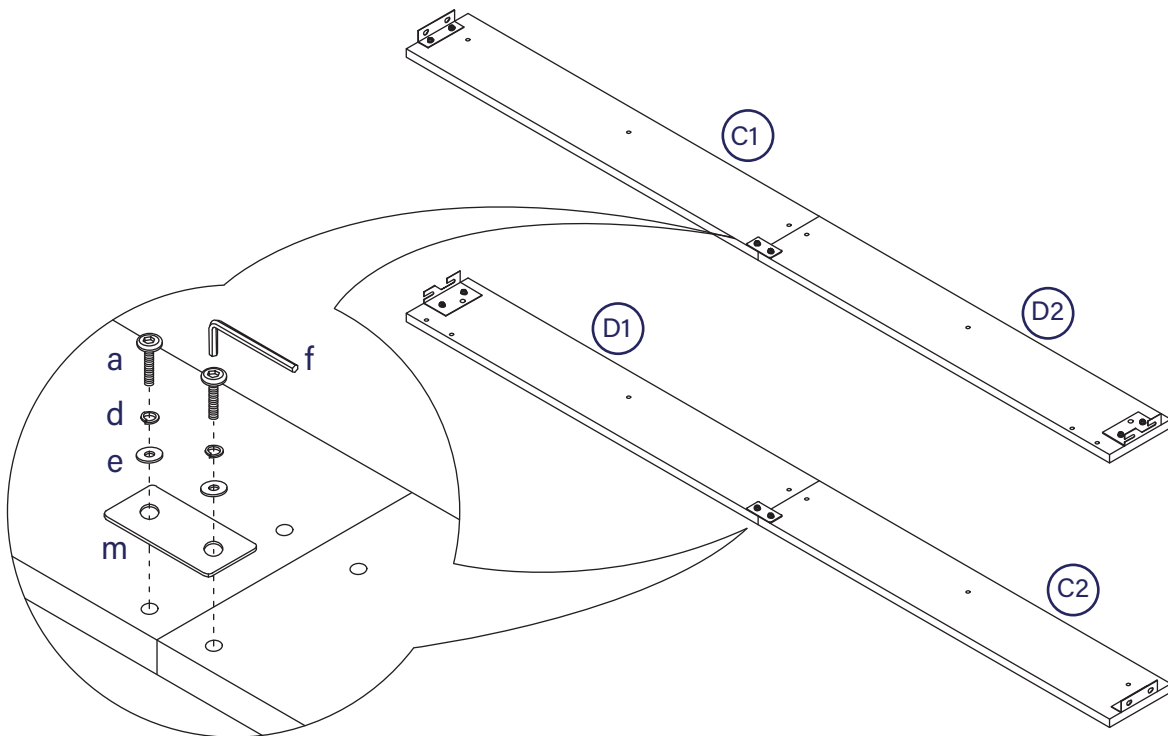

# Bed assembly

2

- a  x4
- d  x4
- e  x4
- m  x2
- f  x1





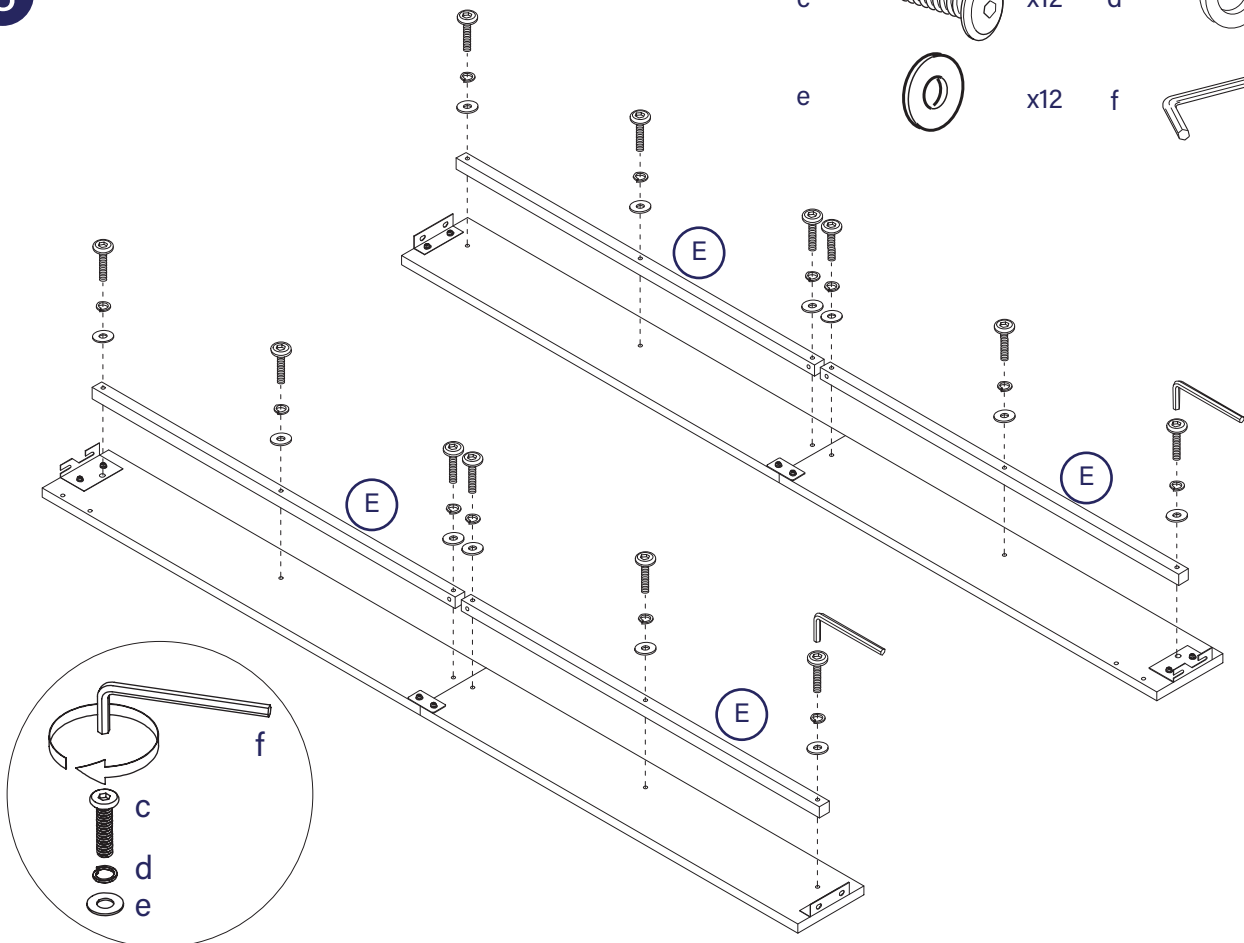

3

- c  x12
- d  x12
- e  x12
- f  x1



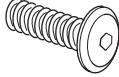



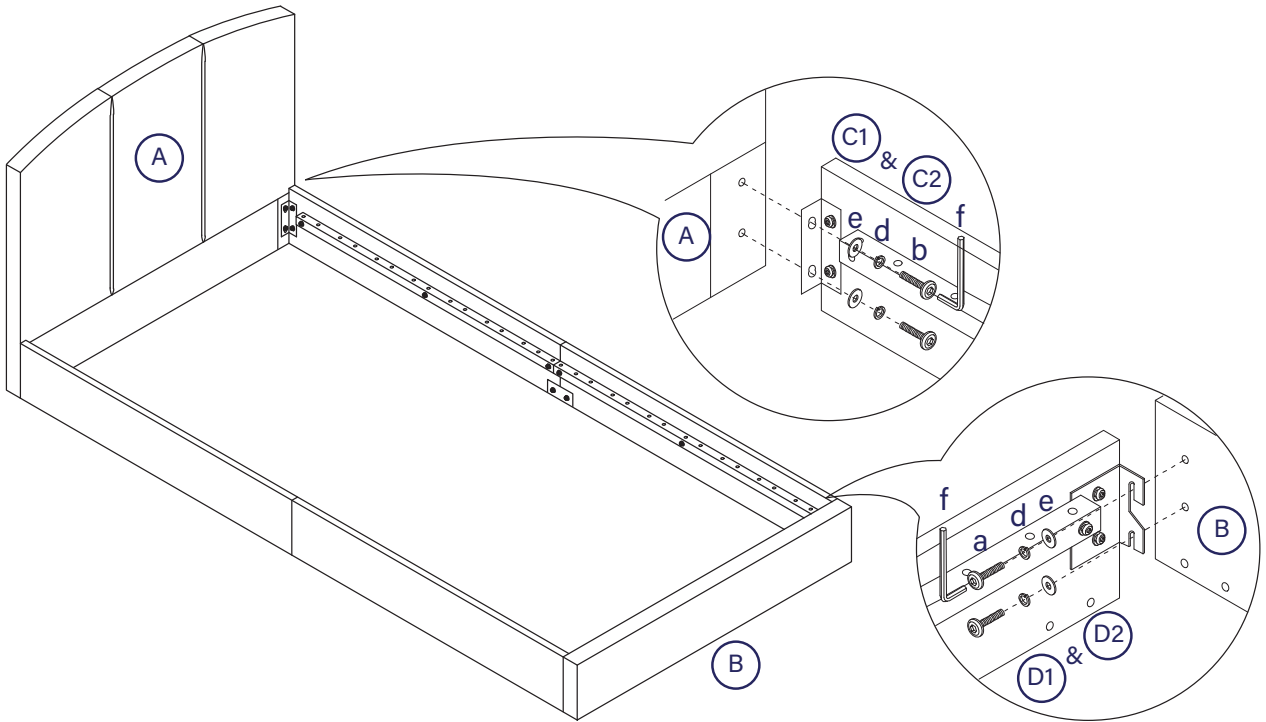

# Bed assembly

4

- a  x4
- b  x4
- d  x8
- e  x8
- f  x1





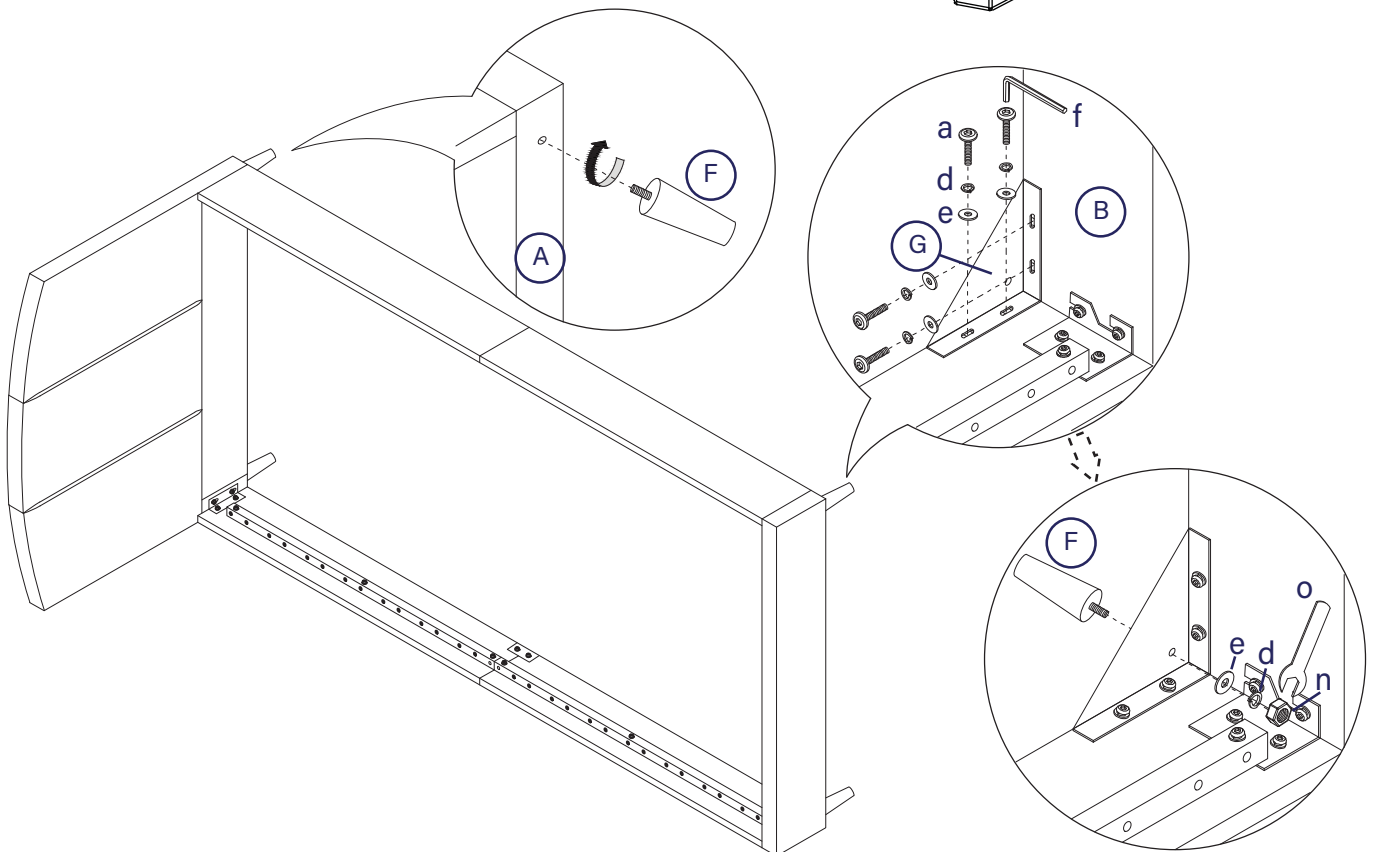

5

- a  x8
- d  x10
- e  x10
- f  x1
- n  x2
- o  x1

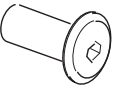

# Bed assembly

6

- g  x4
- h  x4
- i  x4
- j  x4
- k  x2

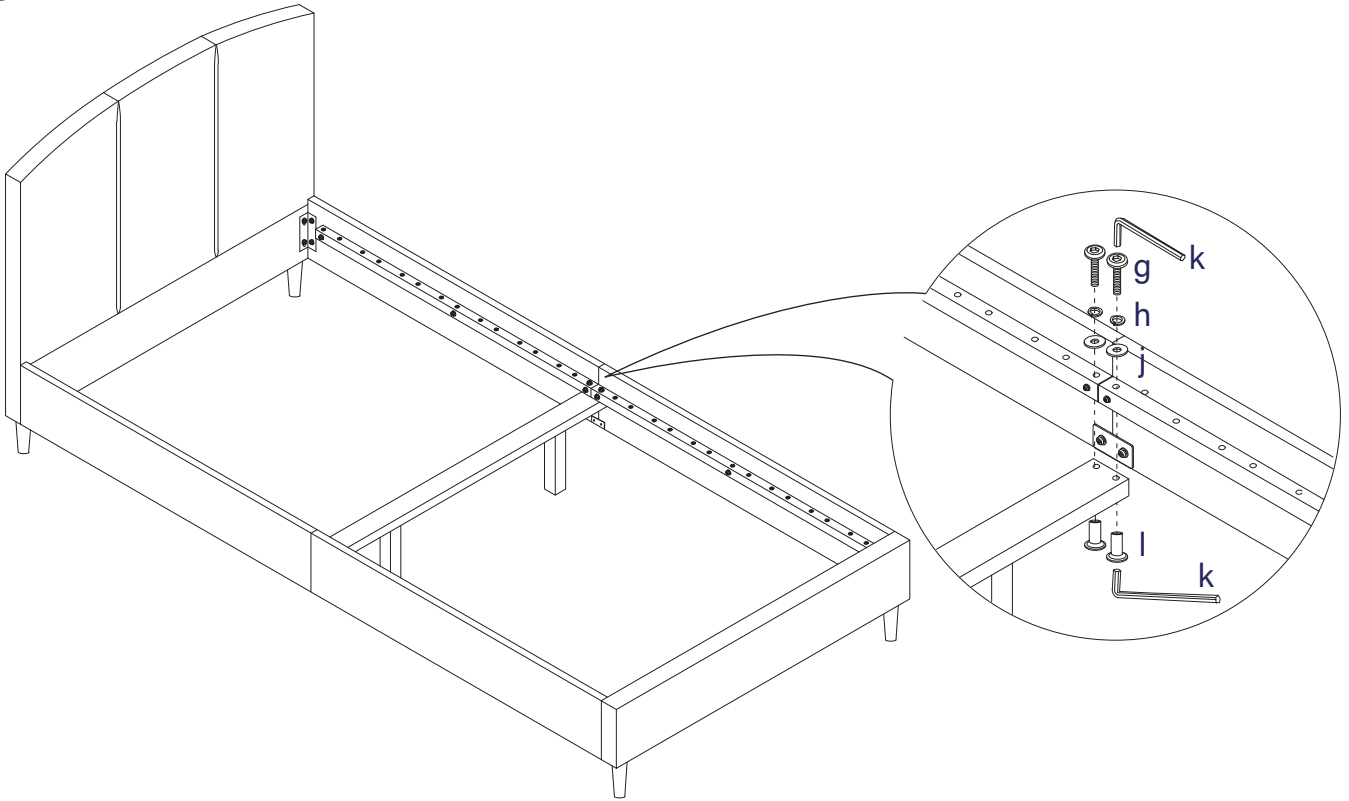

7

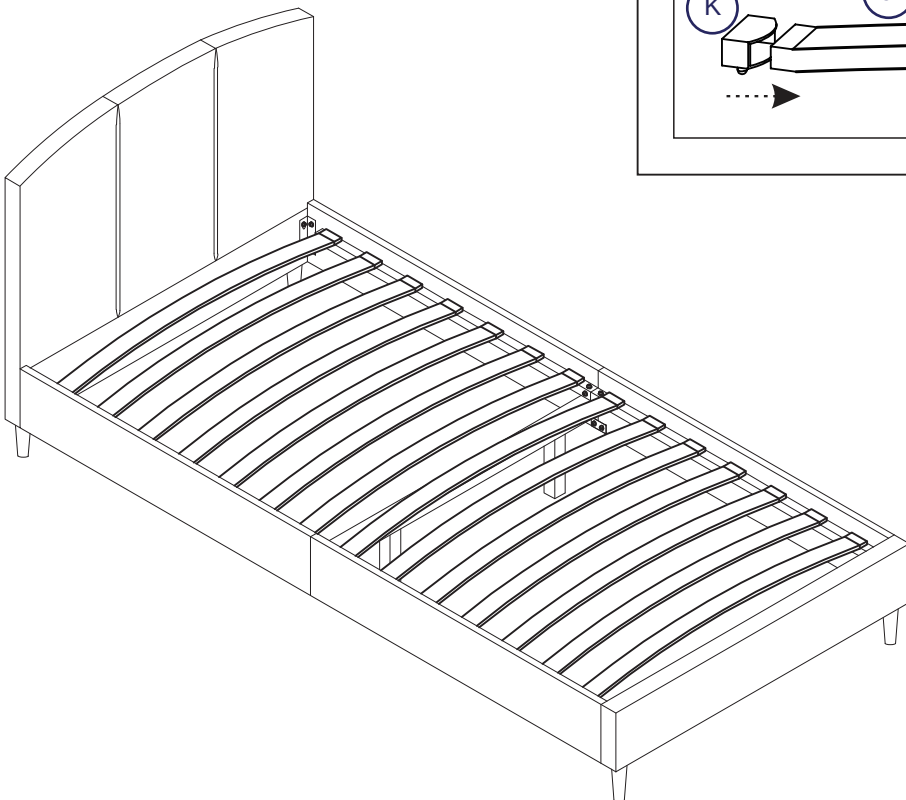
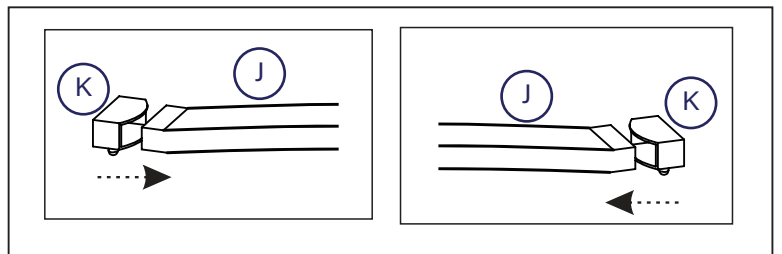

### Overall Dimensions (LWH cm)

Single: 202 x 98 x 100

### Internal Dimensions (LW cm)

Single: 193 x 92

### Gap between slats (cm)

Single: 8.5

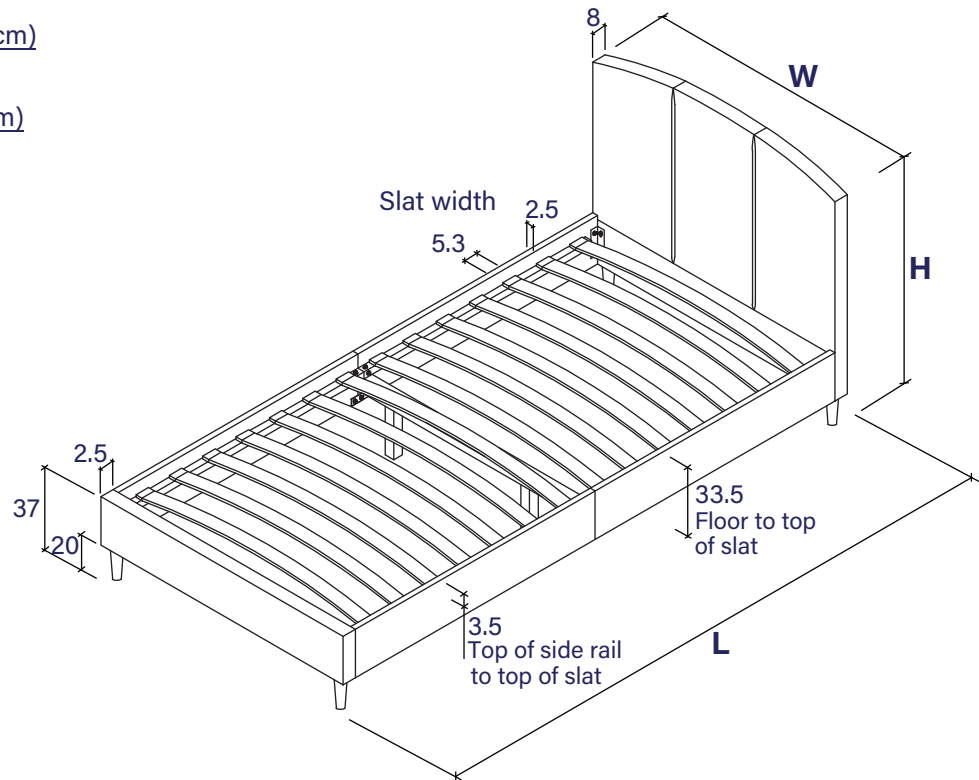

## Care and maintenance

Here are some tips to keep your new bed in tip-top condition



### Cleaning

To clean your new bed, we'd advise using a warm damp cloth or if fabric, remove dust using a low suction vacuum cleaner - please do not use abrasive chemicals or bleach as this may damage the product.



### Checking and moving

Periodically we recommend you check that the screws or fixtures haven't become loose over time. To move your new bed, we recommend lifting it where possible, as dragging or pushing it could cause damage to the legs or flooring.



### Wood

Please note each of our wooden pieces are unique, meaning that markings and shade can vary slightly between beds. Over a period of time, the wood might lighten or fade slightly due to light exposure.



### Fabric

Please note depending on the lighting, positioning and surroundings of your room, the shade of the colour can sometimes appear slightly different. Over a period of time, the colour might lighten or fade slightly due to light exposure.



### Metal

Metal tends to be more resilient to everyday wear and tear. We recommend to gently dust your metal furniture and keep it dry to maintain its look.

**Thank you for shopping with us - we hope you have a great night's sleep**

*Sleep well*





# Little dreamers

Keep the little ones entertained while you assemble your new purchase.



**Dreams**

